

HEATIZON SYSTEMS

RADIANT HEATING AND SNOW MELTING SYSTEMS

GutterMelt[®]

**Self Regulating Roof, Gutter,
Downspout, and Drain Heating Products**

GutterMelt[®] SR Design & Installation Manual

GutterMelt[®] SR is a registered trademark of Heatizon Systems.

© 2017 Heatizon Systems

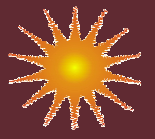
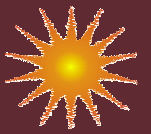

Table Of Contents:

Product Overview.....	4
Cable Specifications.....	5
Warnings and Reminders.....	6
GutterMelt® SR Cable Layout Design Guidelines	7
GutterMelt® Accessories.....	9
GutterMelt® Activation	11
Design and Installation.....	13
Resistance Recording Page	18
Warranty.....	19

Note: Before proceeding with the installation of GutterMelt SR Cable, be sure to read the entire manual.





• Gutters • Downspouts • Roof Eaves

GutterMelt[®]

**Self Regulating Roof, Gutter,
Downspout, and Drain Heating Products**

Heatizon Systems GutterMelt[®] SR rain gutter, eaves trough, downspout, and eave deicing systems provide heat to maintain water flow paths on eaves, and in gutters, downspouts and drains. This heating cable is placed directly on top of the roofing material and/or in the rain gutter, downspouts and drains of a building. Heatizon Systems products can be activated by a large variety of activation alternatives ranging from a simple switch to an automatic temperature moisture sensor.

ADVANTAGES

- Prevents costly damage to roofs, gutters and downspout drains by providing a path for water to exit
- May be applied anywhere snow or ice can accumulate
- May be used on all types of standard roof covering material
- May be installed in rain gutters and downspouts made of metal, plastic, etc
- Industry leading warranty - designed for reliability
- GutterMelt[®] SR is available in 5, 9, and 12 Watts/ft. Special orders deliver up to 24 Watts per foot at 32°F in iced water
- Field cut to length
- Many activation options including temperature/moisture sensors
- Finest quality SR cable available

FAST & EASY INSTALLATION

Heatizon Systems GutterMelt[®] SR system utilizes easy to install SR cable to provide reliable freeze protection of roofs, gutters, downspouts and roof drains. Simply run the cable in gutters using foil tape with pressure sensitive adhesive to secure cable placement, or Heatizon roof clips (Heatizon Part #HT386530 or #HT386530R). Roof clips attach the cable to standard roof covering material. The cable can also be inserted in downspouts using downspout hangers or brackets (Heatizon Part #HT38411 or #HT386412) to support the heating cable. GutterMelt[®] SR cable may be cut to length in the field making installation easy and convenient.

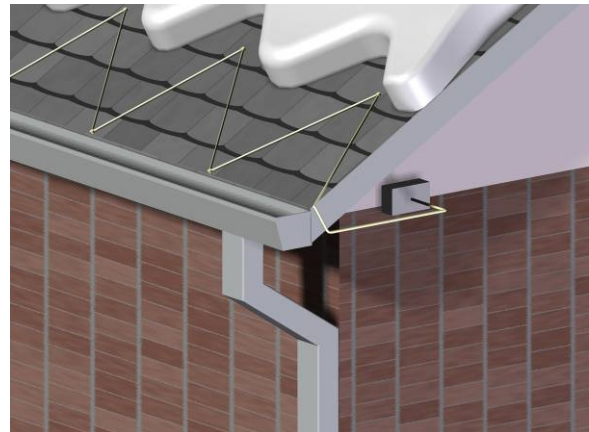

ENERGY EFFICIENT AND COST EFFECTIVE

GutterMelt[®] SR is 100% efficient and automatically adjusts its heat output and energy consumption as the temperature conditions change. When precipitation is expected, simply energize the cable. The cable provides maximum melting power when snow or ice is present, but will automatically regulate its output and save energy when the roof and gutters are clear of snow and ice.

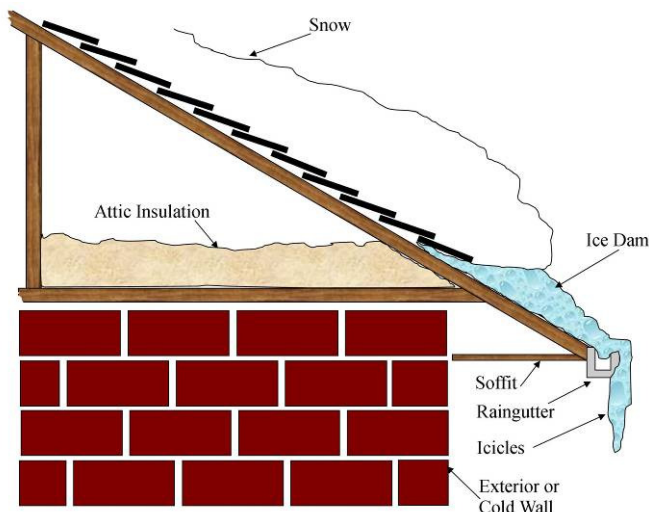

VALUE

Winter has many freeze thaw cycles that can cause millions of dollars of damage to roofs, gutters, downspouts, and drains every year. As winter progresses buildings experience ice buildup which can lead to roof damage, or damage caused by snow and ice falling from the roof. These cycles can cause ice to accumulate and back up under shingles, resulting in ice dams. In some cases, damage appears in the form of soaked insulation, stained, cracked and damaged sheet rock, damp, smelly, rotting wall cavities and stained, blistered and peeling paint. Heatizon Systems has the products and expertise to effectively solve potential winter issues and protect your investment by managing ice dams, minimizing icicles, and keeping ice from accumulating in gutters and downspouts.

What GutterMelt won't do?

- Prevent snow movement on/off the roof
- Remove accumulated snow and ice from roofs, gutters and downspouts

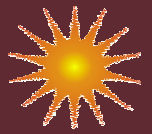

GutterMelt®

Self Regulating Roof, Gutter,
Downspout, and Drain Heating Products

GutterMelt® SR Cable Specifications

Watts per linear foot at 32° in iced water	5	9	12
Cable type	Self Regulating (SR)		
Copper bus wire	22 AWG Min		
Maximum maintenance temperature	185°F (85°C)		
Maximum intermittent exposure temperature	212°F (100°C) T rating: T5		
Voltage AC	120, 208, 240, 277		
Maximum length	Refer to product label		
Approximate thickness/width	0.25" x 0.50"		
Bending radius	1"		
Minimum spacing	2"		
Standard spacing along eave	18" to 24"		

Note: It is important that GutterMelt® SR be installed only by qualified persons who are familiar with the proper sizing, installation, construction and operation of snow melting systems and the hazards involved. GutterMelt® SR products are designed for on roof, in rain gutter, and in downspout drain applications.

Note: GutterMelt® SR must be installed in accordance with the manufacturer's installation instructions, as well as with the National Electric Code (NEC) and Canadian Electrical Code (CEC), part 1, and local codes and regulations.

Note: Ground fault protection must be used when installing all GutterMelt® SR products. Refer to the NEC or CEC for specific requirements.

Note: Do not bend GutterMelt® SR Cable within 1.6" (40mm) of a termination or connection between the GutterMelt® SR Heating Element and the cold lead or power connection.

Electrical Connection Wiring

120VAC, 277VAC Connection		208VAC, 240VAC Connection	
Phase	Conductor	Phase	Conductor
Neutral	Conductor	Phase	Conductor
Ground	Shield	Ground	Shield

Required Tools:
 2500VDC Megohmmeter
 Digital Multimeter (DMM)
 Screwdrivers
 Wire Stripper
 Crimping Tool
 Utility Knife
 Heatshrink Heating Device

Note: GutterMelt® SR should be stored in a cool, dry location.

Warnings

- Failure to follow this Design and Installation Manual and/or incorrect design, installation, handling or maintenance of product may cause electrical shock, injury, damage or fire
- Disconnect all power to GutterMelt® SR and its activators prior to handling, replacing or servicing
- Read this entire Design and Installation Manual prior to installing GutterMelt® SR
- Do not twist, kink, or spiral GutterMelt® SR
- Always test GutterMelt® SR with a Megohmmeter Tester prior to installing, once installation is complete, and prior to energizing. All Megohmmeter tests must be performed at the power termination of the GutterMelt® SR cable, between the braided shield and the core wire(s)
- The minimum installation temperature is 40°F (5°C)
- Use only copper wire from the distribution panel to the GutterMelt® SR cable
- Do not allow the GutterMelt® SR Heating Element to touch or cross other electrical conductors or gas lines
- GutterMelt® SR's braid shield must be grounded to a suitable earth ground
- Do not exceed the maximum circuit lengths listed in this Design and Installation Manual

Reminders

Always remember to test the insulation resistance using a 2500 VDC Megohmmeter, verify and record the actual results at specific points throughout the installation process. A resistance recording page is included in this manual for this purpose. If the taken readings are at anytime less than 20 megohms replace or repair the damaged cable. Do not energize the damaged GutterMelt® SR, and call Heatizon Systems.

Roll the GutterMelt® SR spool to unreel the heating element. Do not pull GutterMelt® SR from the spool.

Verify that the supply voltage matches the design voltage of the GutterMelt® SR product you have purchased.

To avoid the hazard of electric shock, disconnect all power prior to beginning installation of GutterMelt® SR. Effectively ground all installations prior to installing the GutterMelt® SR Heating Element in accordance with CSA Standard C22.1, Section 10, and with the NEC.

Contact Heatizon Systems at 888-239-1232 with any additional questions you may have.

**Heatizon
 GutterMelt® SR Cable
 Available in 5W/ft, 9W/ft, & 12W/ft**

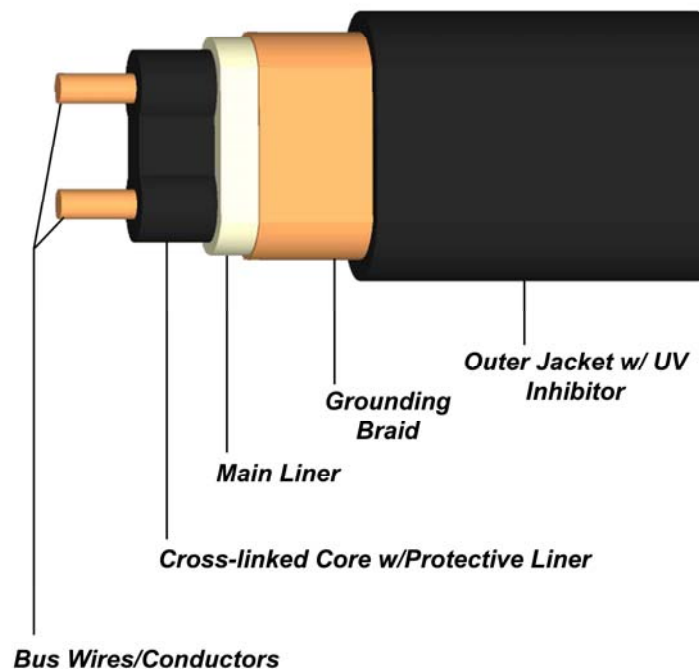

GutterMelt® SR Cable Layout Design Guidelines

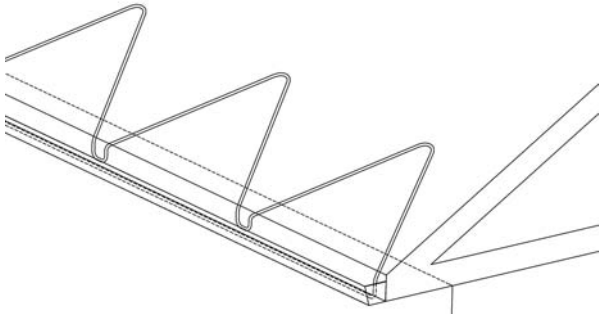

Sloped Roof with Gutter. Run GutterMelt® up the roof until it extends 6" to 12" inside the exterior (cold) wall. Extend at least 2 to 3 inches into the gutter with each loop.

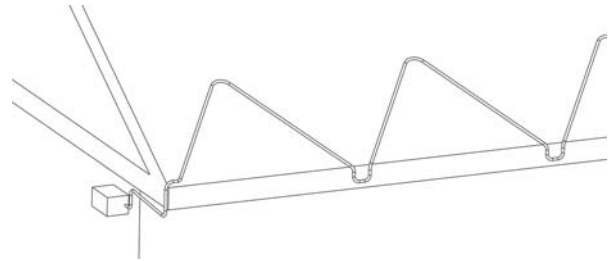

Sloped Roof without Gutters. Heatizon recommends heated gutters and downspouts to provide a continuous path for water. If a gutter is not used, extend a drip loop of GutterMelt® cable past the shingle overhang to allow water to drip free of the roof edge.

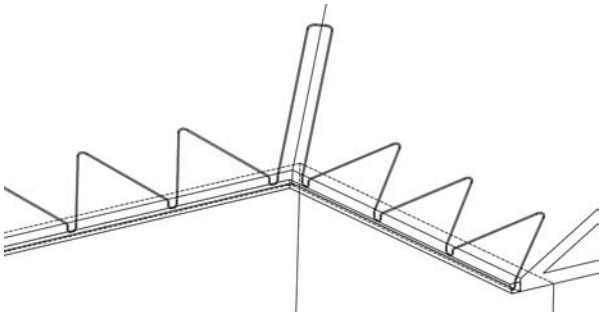

Valleys. Extend GutterMelt® a minimum of two-thirds of the way up each valley with a double run of GutterMelt®, as shown above.

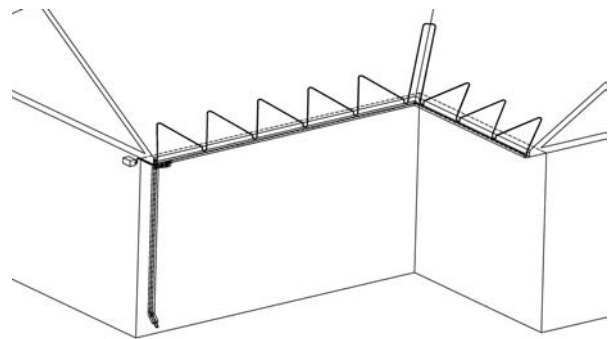

Sloped Roof with Gutter and a Valley. Extend GutterMelt® a minimum of two-thirds of the way up each valley. Extend the GutterMelt® into the gutter. If there is no gutter, the GutterMelt® cable should extend past the shingle overhang to allow water to drip free of the roof edge.

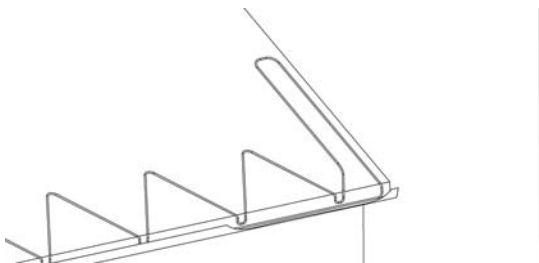

Roof Intersection. Extend a loop of GutterMelt® a minimum of two-thirds of the way up the slope, positioning the cable not more than 2 to 3 inches away from the adjacent wall.

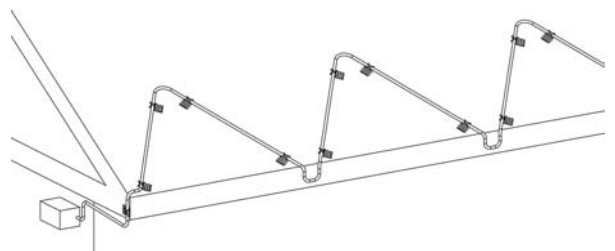

Roof Clips on a Sloped Roof with Asphalt Shingles. (Heatizon Part # HT386530 or HT386530R) are attached with a screw or nail, GutterMelt® cable is installed, then a water-sealing caulking is applied around the clips, screws, and nails to prevent leaks.

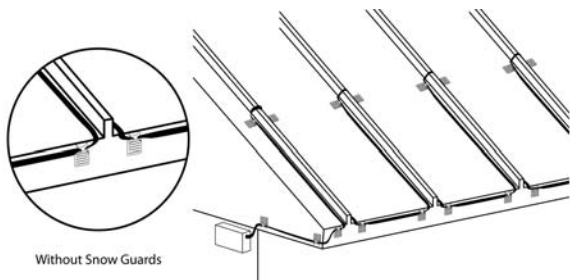

Without Snow Guards

Standing Seam Roof without Gutters. Heatizon recommends heated gutters and downspouts to provide a continuous path for water. The cable is installed up and down each seam traveling to the next seam along the roof face to protect it from sliding snow.

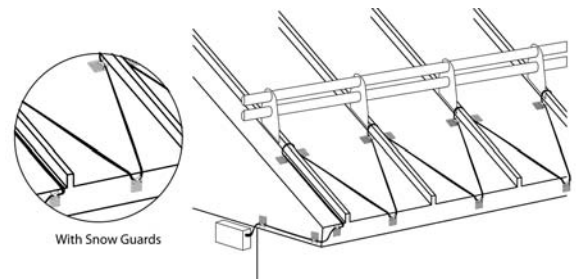

With Snow Guards

Standing Seam Roof without Gutters but with Snow Guards. Heatizon recommends heated gutters and downspouts to provide a continuous path for water. If snow guards are used a zig zag pattern can be used below the snow guards since the snow guards provide protection for the cable. Install roof clips along the front face of the roof eave from water to drain from the roof.

GutterMelt® SR Cable Layout Design Guidelines



Self Regulating Roof, Gutter,
Downspout, and Drain Heating Products

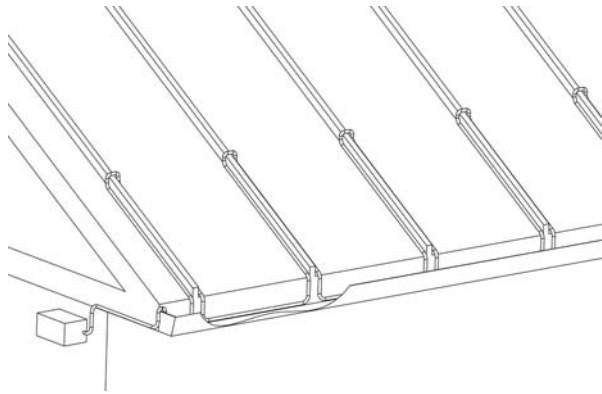

Standing Seam Roof with Gutter. Run GutterMelt® up the seam until it extends 6" to 12" inside the exterior (cold) wall. Extend at least 2 to 3 inches into the gutter with each loop.

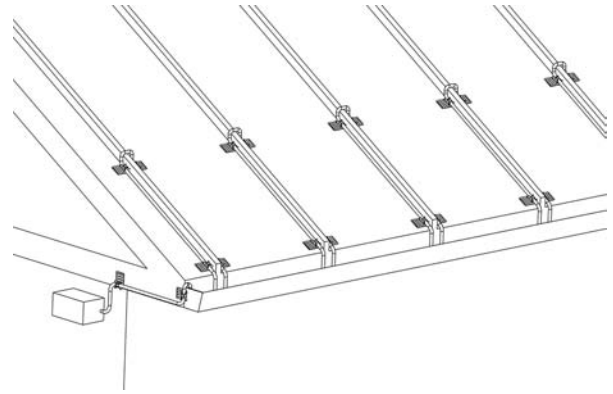

Roof Clips on Standing Seam Roof with Gutter. Roof Clips are attached using Roof Clip Adhesive (Heatizon Part # HT386530AD). Attach the clips to the roof and allow adhesive to cure before threading cable through the clips.

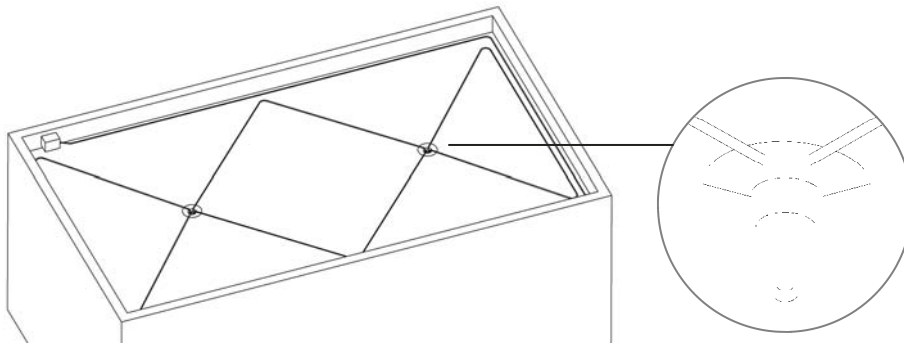

Flat Roof. Position GutterMelt® heating cable around the perimeter of a flat roof. Run GutterMelt® in valleys from the perimeter to the drain and extend the GutterMelt® cable into drains and downspouts so that cable extends at least 12 inches into interior/heated space.

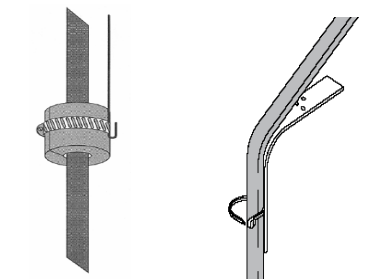
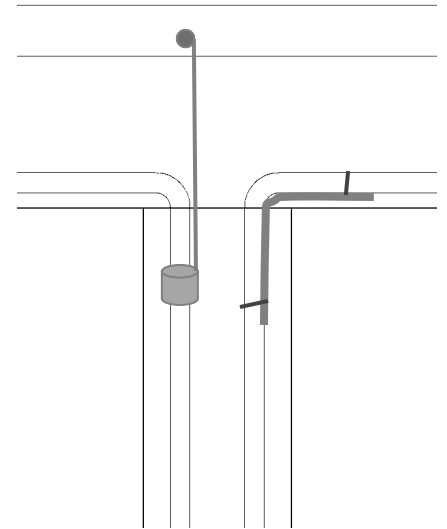

Downspout Hanger Kit

Downspout Hanger Bracket Kit



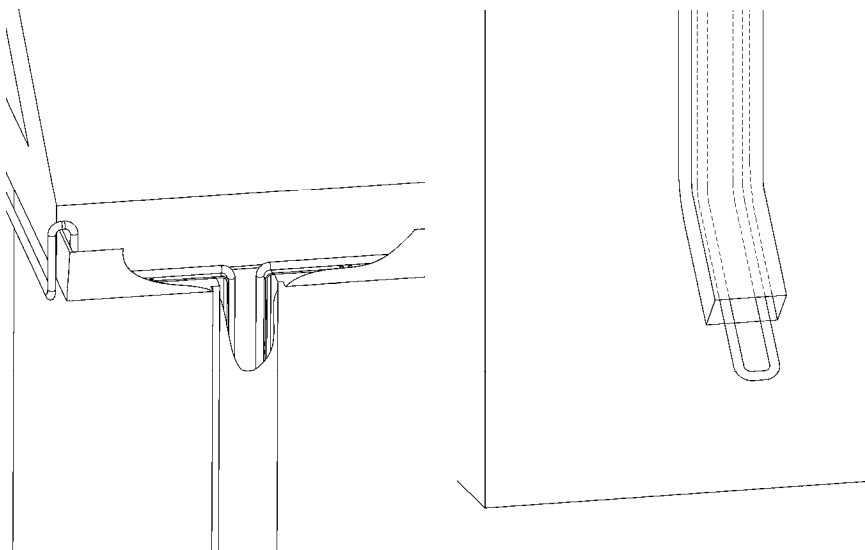



Downspout Attachments and Sharp Edge Protection. Use Downspout Hanger Kit (Heatizon Part # HT386411) or Downspout Hanger Bracket Kit (Heatizon Part # HT386412) to attach GutterMelt® in downspout or drain to prevent damage to cable.

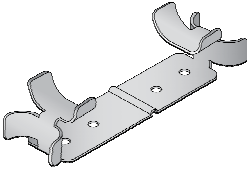

Downspouts. A continuous path for melt water can be maintained by running the GutterMelt® inside the downspout to the bottom, and extend a small drip loop at the bottom of the downspout. If the downspout drain extends below grade, GutterMelt® Cable should extend into a heated area or below the frost line to effectively protect downspouts and drains.

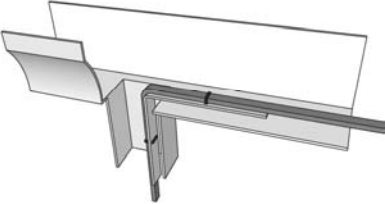
GUTTERMELT® ACCESSORIES

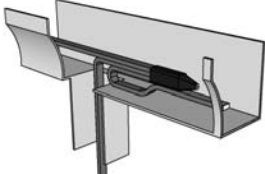

	Part Number	Product	Usage/Description
	HT386530	Roof Clips, Steel	<ul style="list-style-type: none"> • Use to attach GutterMelt® heating cable to roof surface • Five (5) Double or ten (10) Single Clips per package • Accommodate approximately 7 linear feet of GutterMelt® cable • Attached with a mechanical fastener or approved adhesive sealant
	HT386530R	Roof Clips, Aluminum	<ul style="list-style-type: none"> • Use to attach GutterMelt® heating cable to roof surface. • HT386530R includes 10 clips—enough for approximately 7 eave feet of GutterMelt® cable • Attached with a mechanical fastener or approved adhesive sealant
	HT386411	Downspout Hanger Kit	<ul style="list-style-type: none"> • Use to suspend GutterMelt® heating cable in a gutter, downspout or drain • Attached with a mechanical fastener • Includes three (3) downspout hanger assemblies • Prevents heating cable from being damaged at gutter-to-downspout and other transition points
	HT386412	Downspout Hanger Bracket Kit	<ul style="list-style-type: none"> • Used to suspend GutterMelt® in downspout or drain • GutterMelt® is secured to angled bracket; no fasteners required • Includes UV resistant plastic wire ties • Includes two (2) downspout hanger bracket assemblies • Prevents heating cable from being damaged at gutter-to-downspout and other transition points
	HT386521M	End Seal Kit	<ul style="list-style-type: none"> • Use to terminate and seal the non-powered ends of GutterMelt® heating cable • Materials for three (3) end seals • Provides water resistant seal
	HT386505M	Power Connect Kit	<ul style="list-style-type: none"> • Use to terminate one powered end of GutterMelt® heating cable into a junction box and to seal off one non-powered end of cable • Used for a hard-wired connection to supply power • Includes materials for one (1) power connection assembly • Includes one (1) end seal for non-powered cable end
	HT386513	Splice Kit	<ul style="list-style-type: none"> • Connect two heating cables together • Creates a water-resistant connection • Splice Kit contains materials for two (2) splice connections
	HT386513T	Tee Kit	<ul style="list-style-type: none"> • Connect heating cables together to make a tee connection • Creates a water-resistant connection • Tee Kit contains materials for four (1) Tee connection • Includes one (1) end seal for non-powered cable end • Includes sealant and wire ties







GUTTERMELT® ACCESSORIES



Part Number	Product	Usage	Description
HT393473	10 Amp, 120VAC Plug in Cord Set with GFCI	<ul style="list-style-type: none"> Used to terminate one GutterMelt® cable Includes one (1) connection assembly, one (1) end seal assembly, and 1200 Watt three (3) foot cord Will work with up to 75 feet of 12W 120VAC, 100 feet of 9W 120VAC, or 190 feet 5W 120VAC GutterMelt® SR Cable Contains GFCI with 30mA test and reset Power "ON" indicator light 	
HT393473-120	20 Amp, 120VAC Plug in Cord Set Kit with GFCI	<ul style="list-style-type: none"> Used to terminate one GutterMelt® cable Includes one (1) connection assembly, one (1) end seal assembly, and 2400 Watt eight (8) foot cord Will work with up to 150 feet of 12W 120VAC, 200 feet of 9W 120VAC, or 300 feet 5W 120VAC GutterMelt® SR Cable Contains GFCI with 30mA test and reset Power "ON" indicator light Requires NEMA5 20 Amp Outlet Receptacle 	
HT393473-120-15	15 Amp, 120VAC Plug in Cord Set Kit with GFCI	<ul style="list-style-type: none"> Used to terminate one GutterMelt® cable Includes one (1) connection assembly, one (1) end seal assembly, and 2400 Watt eight (8) foot cord Will work with up to 115 feet of 12W 120VAC, 150 feet of 9W 120VAC, or 300 feet 5W 120VAC GutterMelt® SR Cable Contains GFCI with 30mA test and reset Power "ON" indicator light Requires NEMA5 20 Amp Outlet Receptacle 	
HT393473-PT	15 Amp, 120VAC Plug-in Pig Tail Set	<ul style="list-style-type: none"> Used to terminate one GutterMelt® cable Includes one (1) connection assembly, one (1) end seal assembly, and eight (8) foot cord Will work with up to 115 feet of 12W 120VAC, 150 feet of 9W 120VAC, or 300 feet 5W 120VAC GutterMelt® SR Cable Standard Nema5 plug on one end, stripped wires on other end 	
HT393473-240	20 Amp, 240VAC Plug in Cord Set with GFCI	<ul style="list-style-type: none"> Used to terminate one GutterMelt® cable Includes one (1) connection assembly, one (1) end seal assembly, and 4800 Watt eight (8) foot cord Will work with up to 305 feet of 12W 240VAC, 390 feet of 9W 240VAC, or 660 feet of 5W 240VAC GutterMelt® SR Cable Contains GFCI with 30mA test and reset Power "ON" indicator light Requires NEMA6 20 Amp Outlet Receptacle 	
HT386530AD	Roof Clip Adhesive	<ul style="list-style-type: none"> A 10.3 oz cartridge adhesive that is versatile, high strength, one part, hard setting, pick proof, with superb tensile strength 2000 psi tensile strength, tack free 18-24 hours, 50°F min install One cartridge covers about 30-40 roof clips 	
HT376548	Application Tape	<ul style="list-style-type: none"> Used to secure GutterMelt® cable inside gutters or around pipes. Aluminum Application Tape, 150 ft. Roll 	







GUTTERMELT® ACTIVATION



Part Number	Product	Usage Description
 M307	Plug In Thermostatically Controlled Device	Plugs into a 120VAC outlet and turns on when temperature drops to 38°F or less.
 M325	Timer—12-hour	12 hour timer that can operate system from 0 to 12 hours. Features “hold” position; No power required.
 M326A	Temperature Moisture Sensor - One 30A Contact	Activates System when moisture is detected and temperature is below set point. Leaves system on for up to 6 hours. Requires 100-277VAC, Switches up to one 30A Loads.
 M326A-2Z	Temperature Moisture Sensor - Two 30A Contact	Activates System when moisture is detected and temperature is below set point. Leaves system on for up to 6 hours. Requires 100-277VAC, Switches up to two 30A Loads.
 M326ARS	Temperature Moisture Sensor - with Gutter Mounted Sensor - One 30A Contact	Activates System when moisture is detected and temperature is below set point. Leaves system on for up to 6 hours. Requires 100-277VAC, Switches up to one 30A Loads.
 M326CDP	Snow & Ice Sensor/ Controller Display Panel option	Snow & Ice Sensor/Controller Display Panel option for M326A Series Sensor line. Can control, monitor and override the Ice and Snow Sensor/Controller from remote locations. Monitor the status, operating mode and activation state of the sensor. Requires no batteries or AC power - uses power from the snow sensor. May be installed as much as 800 feet away from the snow sensor.
 M336 Series	Electronic Temperature Controller	Electronic Temperature Controller with liquid crystal display to produce constant readout. Touch keypad to program wide set point temperature range (-30° F to 220 ° F) and differential adjustment (1° F to 30° F). Remote temperature sensing up to 400 feet. Requires 120VAC or 240VAC to operate. Also available with 2 Stage Temp Control.

GUTTERMELT® ACTIVATION



	Part Number	Product	Usage Description
	M330 Relay Panel Series	Heatizon Relay Panel 30A & 50A	Heatizon Relay Panel requires 120V, for 120/208/240/277/480 VAC; Also accepts activation devices that switch 12V DC. Contains four relays, master rocker switch, and four auto/manual area rocker switches. M330 switches up to four 30AMP loads. M330-50 switches up to four 50AMP loads. M330-G Model includes GFEP.
	M330G Relay Panel Series	Heatizon Relay Panel 30A & 40A with GFEP	Heatizon Relay Panel requires 120V, for 120/208/240/277/480 VAC; Contains four relays, master rocker switch, and four auto/manual area rocker switches. M330-G switches up to four 30AMP loads. M330G-40 switches up to four 40AMP FLA loads. Both include GFEP.
	M530 Series	Heatizon Contactor Panel 50A with and without GFEP	The M530 Contactor Panel Series can control 1-8 circuits at 208/240/480 VAC, or 1-16 circuits at 120/277/600 VAC and is compatible with many Heatizon activation devices. The M530 do not include GFEP.
	M346	Heatizon Monitor Station Selector Box	Allows up to 12 zones/panels to be activated and monitored by one activation device. Provides two different delay features. Powered by 12VDC, provides 24VAC for activation device as well as up to 12 circuits of monitoring.
	M332	Gutter Controller	Gutter Controller allows Heatizon Systems Line Voltage Cables to be turned on and off whenever a Tuff Cable or ZMesh system is turned on and off. Designed to fit over a standard electrical outlet box. Switches 120/208/240/277 VAC.
	M435	Roof, Gutter and Pipe Moisture Sensor, Outdoor Temperature Sensor and Controller.	Gutter/Roof Deicing with Moisture Sensor, Outdoor Temperature Sensor and Controller. Designed to lay in gutters or hang in downspouts and pipes. The moisture sensor detects moisture while the outdoor temperature sensor monitors ambient temperature. Included up to 2 zones and 3 output relays with 16A load switch capability.
	M515/M515G	Temp Control J-Box 120/277VA	Activates System when temperature is below set point. 0° - 50° F : Temperature Selection 5° F Temperature Differential. Automatic Activation for reliable system operation. Switches 120/277 VAC 50/60hz. FLA 20A @120VAC - FLA 16A @277VAC.
	M516/M516G	Temp Control J-Box 208/240VAC	Activates System when temperature is below set point. 0° - 50° F : Temperature Selection 5° F Temperature Differential. Automatic Activation for reliable system operation. Switches 208/240 VAC. 30A @208VAC - 30A @240VAC

Annual Maintenance

Warning: Always disconnect power to GutterMelt® SR and its activators prior to handling, replacing and/or servicing.

Remove all debris from gutters and downspouts.

Verify the integrity of the GutterMelt® SR by conducting a visual inspection and checking the insulation between the heating elements and the ground shield with a Megohmmeter. Record the value if it exceeds 20 megohms for GutterMelt® SR Cable. If damage to GutterMelt® SR Heating Cable is discovered, and/or the Megohmmeter test yields a megohms reading less than 20, then correctly repair or replace the GutterMelt® SR with new cable prior to energizing.



Design and Installation

STEP 1 PLAN THE LAYOUT

Typical Components of a GutterMelt® SR system include:

- GutterMelt SR heating cable
- Activation device, automatic or manual
- Power connect Kit(s) and End Seal Kit(s)
- Roof Attachment Clips with fasteners and/or adhesive
- Downspout Hanger Kits
- Relay Panel or Contactor Panel for larger projects

Necessary Information:

- Length of eaves, gutters, and downspout drains to be heat traced
- Distance from eave edge to inside the outside wall
- Voltage Available
- Type of Roof covering material

Draw a sketch of the area where GutterMelt® SR snow melt will be installed. The sketch should show all measurements and dimensions in order to determine the area to be snow melted. Determine the location for the GutterMelt® SR temperature/moisture sensor or other activation device.

Note: Make certain to plan for the movement of the water created when GutterMelt® SR melts snow and/or ice from the roof, gutters and/or downspouts to an acceptable refreeze location.

Note: GutterMelt® SR is designed for snow melt applications and to provide a path for water to exit the roof, gutter, and downspout drain.

STEP 2 GUTTERMELT® SR SPECIFICATIONS

PERFORMANCE RATINGS

Watts per linear foot at 32° in iced water	5	9	12
Cable type	Self Regulating (SR)		
Copper bus wire	22 AWG Min		
Maximum maintenance temperature	185°F (85°C)		
Maximum intermittent exposure temperature	212°F (100°C) T rating: T5		
Voltage AC	120, 208, 240, 277		
Maximum length	Refer to product label		
Approximate thickness/width	0.25" x 0.50"		
Bending radius	1"		
Minimum spacing	2"		
Standard spacing along eave	18" to 24"		

POWER OUTPUT CURVE

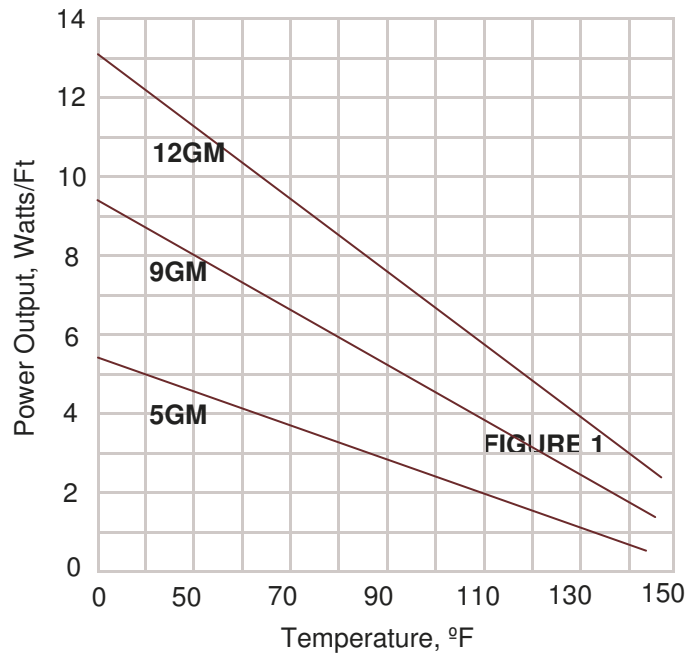

BREAKER SIZING AND MAX CIRCUIT LENGTH

120 Volt Breaker Sizing vs Max Circuit Length (ft)

	15A	20A	30A	40A
5GM1 If started at	40°F	300	—	—
	0°F	200	270	330
	-20°F	180	230	330
9GM1 If started at	40°F	150	200	210
	0°F	95	125	190
	-20°F	85	100	170
12GM1 If started at	40°F	115	150	180
	0°F	70	95	145
	-20°F	60	85	120

240 Volt Breaker Sizing vs Max Circuit Length (ft)

	15A	20A	30A	40A*
5GM2 If started at	40°F	660	—	—
	0°F	410	560	660
	-20°F	360	480	660
9GM2 If started at	40°F	295	390	420
	0°F	195	250	375
	-20°F	170	225	340
12GM2 If started at	40°F	230	305	360
	0°F	150	200	300
	-20°F	130	175	260

208 Volt Breaker Sizing vs Max Circuit Length (ft)

	15A	20A	30A	40A*
5GM1 If started at	40°F	505	—	—
	0°F	475	650	765
	-20°F	420	560	765
9GM1 If started at	40°F	320	425	455
	0°F	210	270	405
	-20°F	185	245	370
12GM1 If started at	40°F	240	315	375
	0°F	155	210	310
	-20°F	135	180	270

277 Volt Breaker Sizing vs Max Circuit Length (ft)

	15A	20A	30A	40A*
5GM2 If started at	40°F	570	—	—
	0°F	355	485	570
	-20°F	310	415	570
9GM2 If started at	40°F	270	355	385
	0°F	180	230	345
	-20°F	155	205	310
12GM2 If started at	40°F	220	290	340
	0°F	140	190	285
	-20°F	125	165	245

* Appropriate sized butt splices may need to be sourced separately

Design and Installation



STEP 3 CONTACT YOUR GUTTERMELT® SR SUPPLIER

Contact your GutterMelt® SR supplier for assistance in ordering the material needed. When materials arrive, examine the GutterMelt® SR roof deicing system design, and compare the list of materials ordered to those received.

STEP 4 PREPARE AREA

Ensure that the roofing material, gutters and/or downspout drains have been properly installed, and that drainage has been satisfactorily addressed.

Eliminate any nails, staples, or any other objects that may damage the GutterMelt® SR Heating Element prior to installation.

Clean and dry the rain gutters so that the provided foil tape will adhere to the bottom and hold the GutterMelt® SR cable in place.

STEP 5 MEASURE & RECORD RESISTANCE

Remove the GutterMelt® SR Heating Element from the box. Using a 2500 Vdc Megohmmeter, check the insulation resistance of the Heating Element to make certain it is greater than 20MΩ. Confirm the Megohmmeter result by measuring the resistance with a Digital Multimeter and record the value measured on *Resistance Recording Table* at the back of this manual. Resistance measurement must be taken several times during the installation process: Immediately upon removal from the packaging and after installation of the heating element. GutterMelt® SR should also be checked for electrical continuity.



STEP 6 LOCATION SELECTION

Determine the location of the connection points between the power supply and the GutterMelt® SR Cable.

Next, determine the location of the activation device.

Remember, an automated activator is the “eyes and ears” of the roof, gutter, and downspout system. It is important that it be installed in a location that will allow it to turn the roof deicing system “on” when it is needed and “off” when it is not needed.

Manual activators require human action—as a result they should be placed in a location that is convenient and easily accessible.

Design and Installation



STEP 7 INSTALL THE ACTIVATOR

Install the selected activator by carefully following the specific set of instructions that were included in the packaging.

Warning: Do not allow the sensor conduit to cross the GutterMelt® SR Heating Element. Do not allow any part of the activator to touch the GutterMelt® SR Heating Element.

Note: Visually check GutterMelt® SR Heating Cable for breaks, cuts, nicks, etc. If damage has been done to GutterMelt® SR Heating Cable or any of its components, please file a claim with the delivery service and call Heatizon Systems, 888-239-1232.

STEP 8 INSTALL GUTTERMELT® SR HEATING ELEMENT

Using the determined spacing of GutterMelt® SR Heating Element, and the calculated length of GutterMelt® SR Heating Element, begin the installation. Heatizon Systems recommends a maximum 2 foot spacing along the eave edge for roof applications, and two runs of GutterMelt® SR for gutter and downspout applications. Note that the minimum distance between the GutterMelt® SR Heating Element runs should not be less than 2 inches.

Install the GutterMelt® SR Heating Element so that the starting and ending connection points and any activation sensor are in their desired locations. Make certain that the power end of GutterMelt® SR Cable returns back to the GutterMelt® SR Termination Box, Junction Box, or Heatizon Relay Panel.

Begin laying the GutterMelt® SR Heating Element in and across the area to be melted in evenly spaced runs.

Use **Roof Clips** purchased from your Heatizon Systems Distributor to attach GutterMelt® SR to the roof covering material.

Use **Foil Tape** purchased from your Heatizon Systems Distributor to attached GutterMelt® SR to the rain gutter.

Use **Downspout Hangers** purchased from your Heatizon Systems Distributor to install GutterMelt® SR into the downspouts or drains.

After installing GutterMelt® SR Heating Element take resistance measurements. Using a 2500 Vdc Megohmmeter, check the insulation resistance of the Heating Element to make certain it is greater than 20MΩ. Confirm the Megohmmeter result by measuring the resistance with a Digital Multimeter and record the value measured on *Resistance Recording Table* at the back of this manual. Resistance measurement must be taken several times during the installation process: Immediately upon removal from the packaging, after installation of the heating element. GutterMelt® SR should also be checked for electrical continuity.



Note: Always roll or uncoil the GutterMelt® SR to unreel the heating element. Do not pull GutterMelt® SR from the spool or coil. Never energize GutterMelt® SR Heating Cable while it is rolled or coiled on the spool.

Warning: Do not damage or subject the GutterMelt® SR Heating Element to mechanical or shear stress. Never cut or damage the insulator on GutterMelt® SR Heating Element. Do not allow GutterMelt® SR to cross or touch gas lines or other electrical conductors.

STEP 9 INSTALL GUTTERMELT® END KIT, POWER CONNECTION KITS

Commonly used connection kits and accessories are listed in this manual. See www.heatizon.com for additional information.

Design and Installation



STEP 10 CONNECT POWER SUPPLY & ACTIVATION

The connection of an acceptable ground fault protection device power supply and the activation device must be done in accordance with the National Electrical Code (NEC) and the Canadian Electrical Code (CEC). The braided shield from GutterMelt® SR Cable must be wired to Ground for all primary power installations.

Caution: Never energize GutterMelt® SR until:

1. The GutterMelt® SR Cable has been verified to be free of damage.
2. All splices and all power kit and end kit connections have been inspected.
3. A Megohmmeter Test has been used to verify a minimum of 20 MegOhms between the heating element and the braided shield.

STEP 11 TROUBLESHOOTING

Problem: GutterMelt® SR Cable fails the Megohmmeter Test
Potential Causes:

- Check field installed power/end terminations and connection splices; correct as necessary
- Inspect the GutterMelt® SR Cable for damage to the insulator, exposed braided shield, and/or contact between the braided shield and the core wire(s). Replace entire length of damaged GutterMelt® SR Cable

Call Heatizon Systems technical support @ 801-293-1232 if additional assistance is required.

Note: In the event the power/end termination or splices are not the cause of the failed Megohmmeter Test and the GutterMelt® SR Cable has not been damaged in any way, remove and replace the entire length of GutterMelt® SR. For Warranty claims, please return the entire length of GutterMelt® SR to Heatizon Systems, with the end termination and power termination connections intact, for evaluation prior to replacement.

STEP 12 COMPLETE AND ATTACH LABELS

Place the included labels in the following locations:

- Electrical Panel Label — Inside door at electrical service panel. This label matches the information printed on the GutterMelt® SR Cable
- Stop Sign Warning Label — on or near the area to be heated by GutterMelt® SR Cable

STEP 13 COMPLETE WARRANTY CERTIFICATE

Mail in the warranty certificate immediately after installing the GutterMelt® SR system. Failure to complete the warranty card could void the manufacturer's warranty. The warranty is subject to the guarantee conditions listed on the warranty certificate, and upon documentation that the required resistance readings were completed. You may wish to keep a copy of the warranty card for your reference.

ELECTRIC SHOCK OR FIRE HAZARD
GutterMelt® Self Regulating Heat Trace System

Disconnect all power before installing or servicing heating cable. GutterMelt® SR must be installed and serviced by a qualified person in accordance with the National Electrical Code, NFPA 70, and/or the Canadian Electric Code. GutterMelt® SR must be effectively grounded to eliminate shock hazard. Damaged or worn heating cable or accessories must be replaced immediately. Failure to follow these warnings could result in personal injury or damage to property. For more information, contact Heatizon Systems at www.heatizon.com or call 801-293-1232.



Resistance Recording Page

Use a Digital Multi Meter to measure continuity through the GutterMelt® SR Heating Element, and no continuity between the heating element and the braided ground shield. GutterMelt® SR Cable should be tested using a megohmmeter set at 2500 VDC at least twice. The measured value should not be less than 20 Megohms. Record all test results below.



Prior to Installation (When removed from Package)		After Installation of GutteMelt® SR Heating Element	
MΩ @ 2500VDC		MΩ@2500VDC	
Date	Time	Date	Time

Customer Warranty Information

Name	<input type="text"/>		
Address	<input type="text"/>		
City	<input type="text"/>	State	<input type="text"/>
		Zip	<input type="text"/>
Phone	<input type="text"/>	Email	<input type="text"/>

Purchased Product Details

Model	<input type="text"/>	Size	<input type="text"/>	Sq. Ft.
Manufacture Date	<input type="text"/>	Serial Number (if applicable)	<input type="text"/>	
Watts & Volts	<input type="text"/>	Ohms	<input type="text"/>	Ω

Heatizon Systems GutterMelt® SR Warranty

Heatizon Systems warrants GutterMelt® SR Heating Element to be free from defects in material and workmanship for a period of ten (10) years and Activation Device(s) for a period of one (1) year. Such warranty periods shall commence on the date of shipment by Heatizon Systems. If any parts are found to be defective in manufacture during such time period, Heatizon Systems will, at its sole option, replace or repair defective parts.

This Limited Warranty applies only if articles sold hereunder (a) are selected, designed, and installed according to instruction and operation manuals furnished by Heatizon Systems and installed in a "workmanlike manner" according to the building association standards adopted by Heatizon Systems, (b) remain in their originally installed location, (c) are connected to proper power supplies, (d) are not misused or abused, (e) show no evidence of tampering, mishandling, neglect, damage (accidental or otherwise), modifications or repair without the approval of Heatizon Systems, or damage done to the product by anyone other than Heatizon Systems, and (f) are installed in accordance with applicable code requirements. Any warranty claims must be made in writing, no later than one (1) month following expiration of the warranty period, and must be accompanied by the warranted part or component. Any claim not made in such manner shall not be honored by Heatizon Systems.

This Limited Warranty does not cover:

1. The workmanship of any installer of Heatizon Systems radiant panel heating products.
2. Any Heatizon Systems radiant heating products that have a failure or malfunction resulting from improper or negligent operation, installation, accident, abuse, misuse, unauthorized alteration or improper repair or maintenance.
3. Any Heatizon Systems radiant heating products that have had components not purchased from Heatizon Systems integrated into or connected to them.
4. Any labor costs for removal of alleged defective part(s) and/or reinstallation of replacement part(s), transportation to and from Heatizon Systems (if necessary) and any other material necessary to perform the exchange or repair.
5. Any Heatizon Systems heating products that have not been properly registered by completion and return of the Warranty Registration Card attached hereto within ninety (90) days of the date of sale.

DISCLAIMER OF WARRANTIES:

This warranty described above is in lieu of all other warranties, express or implied, including but not limited to any implied warranties of fitness for a particular purpose and merchantability. Heatizon Systems expressly disclaims and excludes any liability for losses, expenses, inconveniences, consequential, incidental, indirect, or punitive damages for breach of any express or implied warranty. By installing and/or purchasing Heatizon Systems products, you accept the terms of this limited warranty.

Some states do not allow the exclusion or limitation of incidental or consequential damages, or limitations on how long an implied warranty lasts, so the above limitations and exclusions may not apply to you. This Limited Warranty gives you specific legal rights, and you may also have other rights which may vary from state to state.

How to make a Warranty Claim

1. Gather the following information:
 - Date of purchase
 - Who product was purchased from
 - Date of installation, if installed
 - Names and phone numbers of electrician/installer
 - Completed resistance recording page from installation
 - Serial number (if applicable) from product label
2. Contact Heatizon Systems for a Return Materials Authorization number, and information on the next required steps to complete your warranty claim.

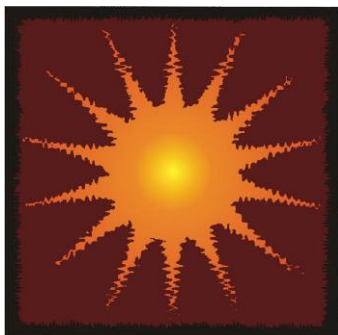

HEATIZON
S Y S T E M S

Mail: Heatizon Systems
4137 South 500 West
Murray, UT 84123
USA

Phone: (801) 293-1232

Toll Free: (888) 239-1232

Fax: (801) 293-3077

Email: info@heatizon.com

Website: www.heatizon.com

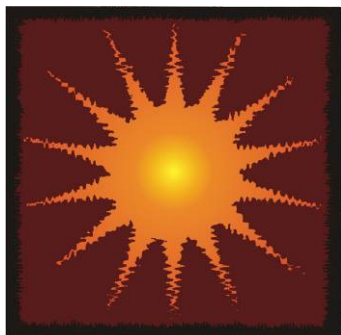

HEATIZON
SYSTEMS

Mail: Heatizon Systems
4137 South 500 West
Murray, UT 84123
USA

Phone: (801) 293-1232

Toll Free: (888) 239-1232

Fax: (801) 293-3077

Email: info@heatizon.com

Website: www.heatizon.com